

- Multi Channel Power Control
- High accuracy
- Up to 24 output 25A each
- Suitable to communicate with PLC & Multiloop
- Dedicated to solve applications
- Space & wiring reduction
- Most popular Field Bus available

CD AUTOMATION

POWERED BY INNOVATION

REVO PN

POWER NETWORK



**Multi-Channel SCR Power Controller
Suitable to control Electric Heaters
and IR Lamps in Industrial Heating Systems**



www.cdautomation.com

Revo PN Catalog 2021

HAVE YOU CONSIDERED HOW POWER PEAKS COULD BE A PROBLEM TO YOUR BUSINESS?

The REVO PN unit is designed to handle applications with multiple zones. This enhanced unit, thanks to a particular algorithm, minimizes your energy costs through the synchronization and the power limit for each zone.

Revo PN keeps your instantaneous power within the limits of your electricity supply contract.



REVO PN Power Network

Created specifically for industrial multi-zone applications, REVO PN can be configured to control between 4 and 24 channels/zones. Each zone is sized for 25A max.

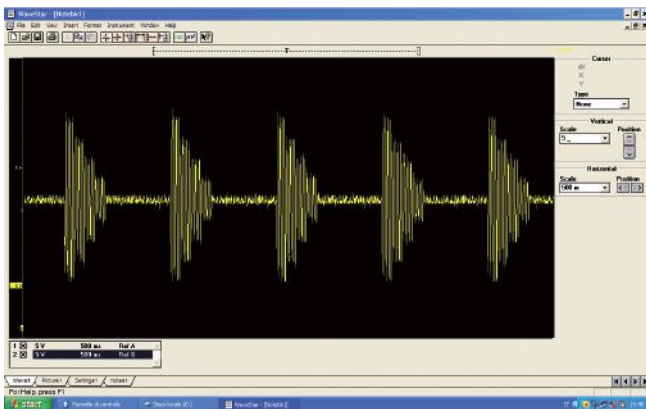

Without power control optimization

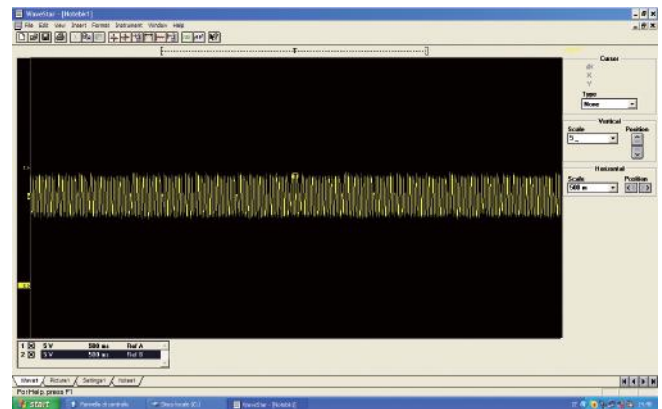

With power control optimization

Important power control functionality is offered by REVO PN including:

- Elimination of power overshoot
- Power factor maintained close to 1
- Stay connected with the most popular Field Bus protocols
- Eliminate use of PLC output modules by using comms for Power to CPU connections
- Alarm notification per zone of heater break and thyristor short circuit
- Product footprint for 24 zone package 60% less than using standard thyristor stacks
- Dramatic savings with less wiring & smaller cabinet enclosures
- REVO PN's considered design not only helps you save start-up costs but ensures you keep on saving money throughout the products lifetime.

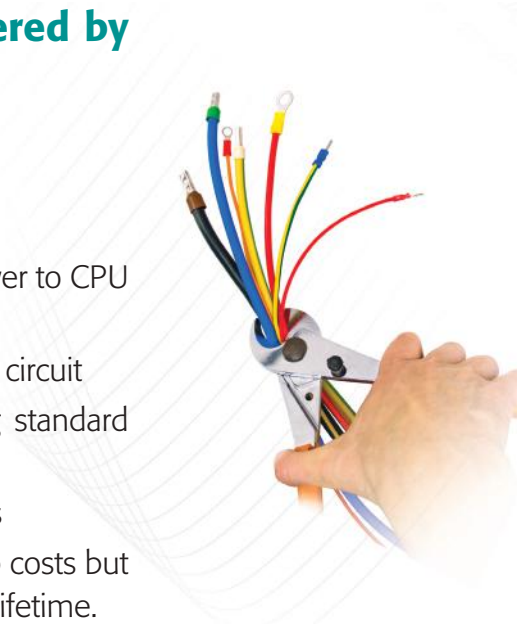

POWER OPTIMIZATION

Without REVO PN

With REVO PN

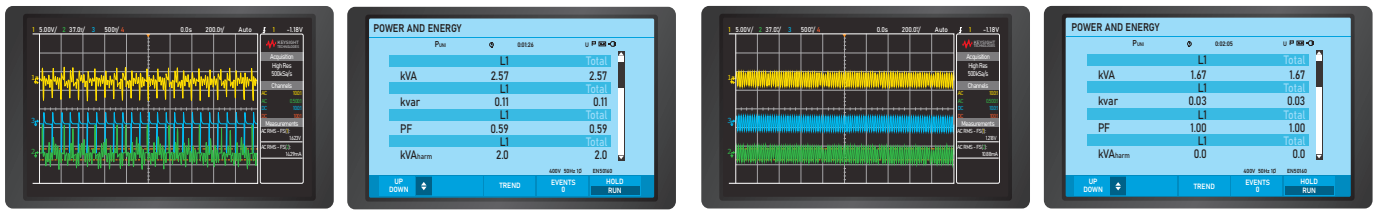

In multi-zone applications, the non-synchronized insertion of the different loads can create a simultaneity of insertions generating peak current that produces disturbances on the power line. REVO PN distributes the power demand of the individual zones keeping the line current as constant as possible.

NETWORK DISTURBANCE

Without REVO PN

With REVO PN

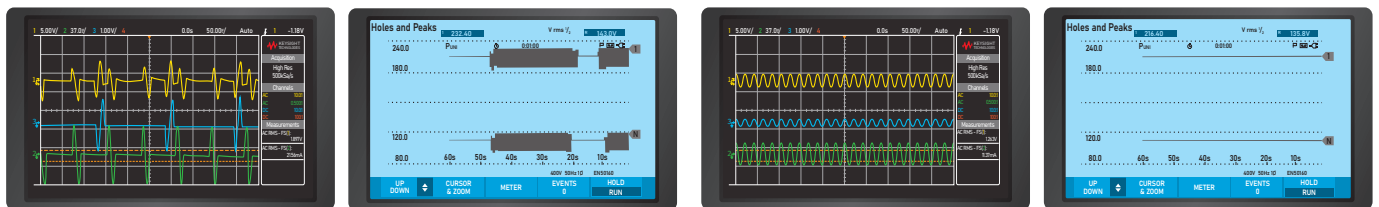

The insertion of loads that are not synchronized on the power line can cause disturbances, such as fluctuations in the mains voltage (Flickering), network holes and losses on the power cables.

HARMONIC COMPONENT

Without REVO PN

With REVO PN

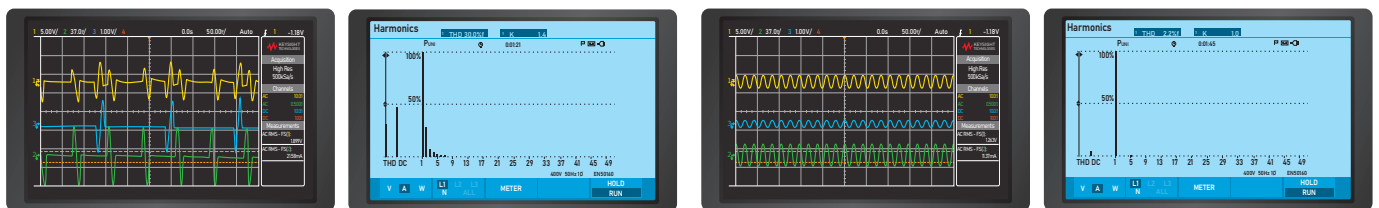

The management and insertion of unsynchronized loads can lead to an increase in the harmonic component generated (THD). This effect increases losses, generates noise and can generate overheating of the power cables.

OPTIMIZATION OF ENERGY COST

Without REVO PN

With REVO PN

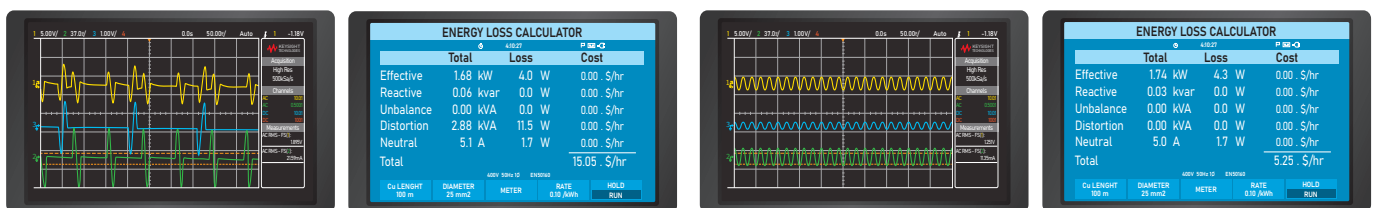

Thanks to its control strategy and the distribution of the power required in the management of multizone loads, REVO PC keeps the Power Factor values close to 1.

REVO PN FEATURES

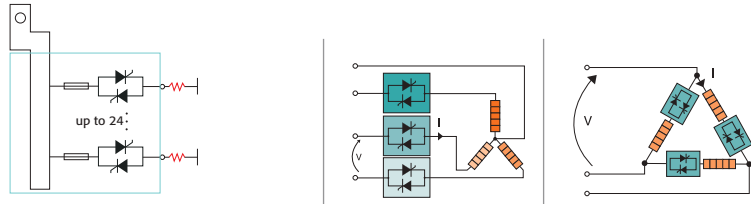

CODE	RPN 104	RPN 108	RPN 112 RPN 120	RPN 116 RPN 124	RPN 412	RPN 424	RPN 612	RPN 624	REVO PB (PN Basic)
CONNECTION	Phase-Phase		Phase-Neutral		F-N connect. Shared on the three phases		F-F connect. Shared on the three phases		
CHANNELS	4	8	12 20	16 24	12	24	12	24	3
N° of Control Legs for each Channel	2PH	2PH	3PH	3PH	1PH	1PH	1PH	1PH	1PH
General Features	Polymeric V2								
IP code	20								
Aux Voltage	24Vdc								
Input Features	4	8	12 20	16 24	12	24	12	24	3
Configurable Digital Input calibration	max. 50mA								
Output features	25A for each channel, Fuse I ² T 1260 A ² S								Up to 90A
Firing	Half Cycle at 50% power demand		Not Available			Standard			Standard
	Single Cycle at 50% power demand		Standard			Standard			Standard
Control	Open Loop		Standard						
	Power Feedback		Standard						
Features	Heater Break + Thyristor short circuit		Standard						
	Current Measurement on communication		Standard						
	Voltage measurement		Standard						
	Power measurement		Standard						
	Three Phase balancement		Standard						No
Communication	N°1 Modbus TCP and N°3 Modbus RTU Slave		Standard						1
	Modbus Master		Yes						No
	Profibus DP and Modbus TCP		Option						External Module
	Profinet and Modbus TCP		Option						
	Ethernet IP and Modbus TCP		Option						
Digital Input	N° of Digital Input		4						3
	Enable Disable Function		OK						
Relay Output	Relay Output		Option						
Option	REVO KP PC		Option						
Temperature Control	Can be added externally		Option						No
Approval	CE EMC		OK						

REVO PN FAMILY



4 - 8 One Phase Channel
(RPN104- RPN108)



12 - 16 One Phase Channel
(RPN112- RPN116-RPN120-RPN124)



12 - 24 One Phase Channel shared on the three phases
20 - 24 One Phase Channel

Each zone Include:

- 480V Max Voltage 25Amp
- Thyristor Units with high I²T
- Integrated Extra Rapid fuse
- Current transducer
- Voltage transducer
- Communication RS485 Modbus TCP/Profinet/Profibus
- Synchronizing Circuit
- Digital Input and Relay Output
- High precision current transducer
- HB Alarm

CONNECTIVITY AND CONFIGURATION

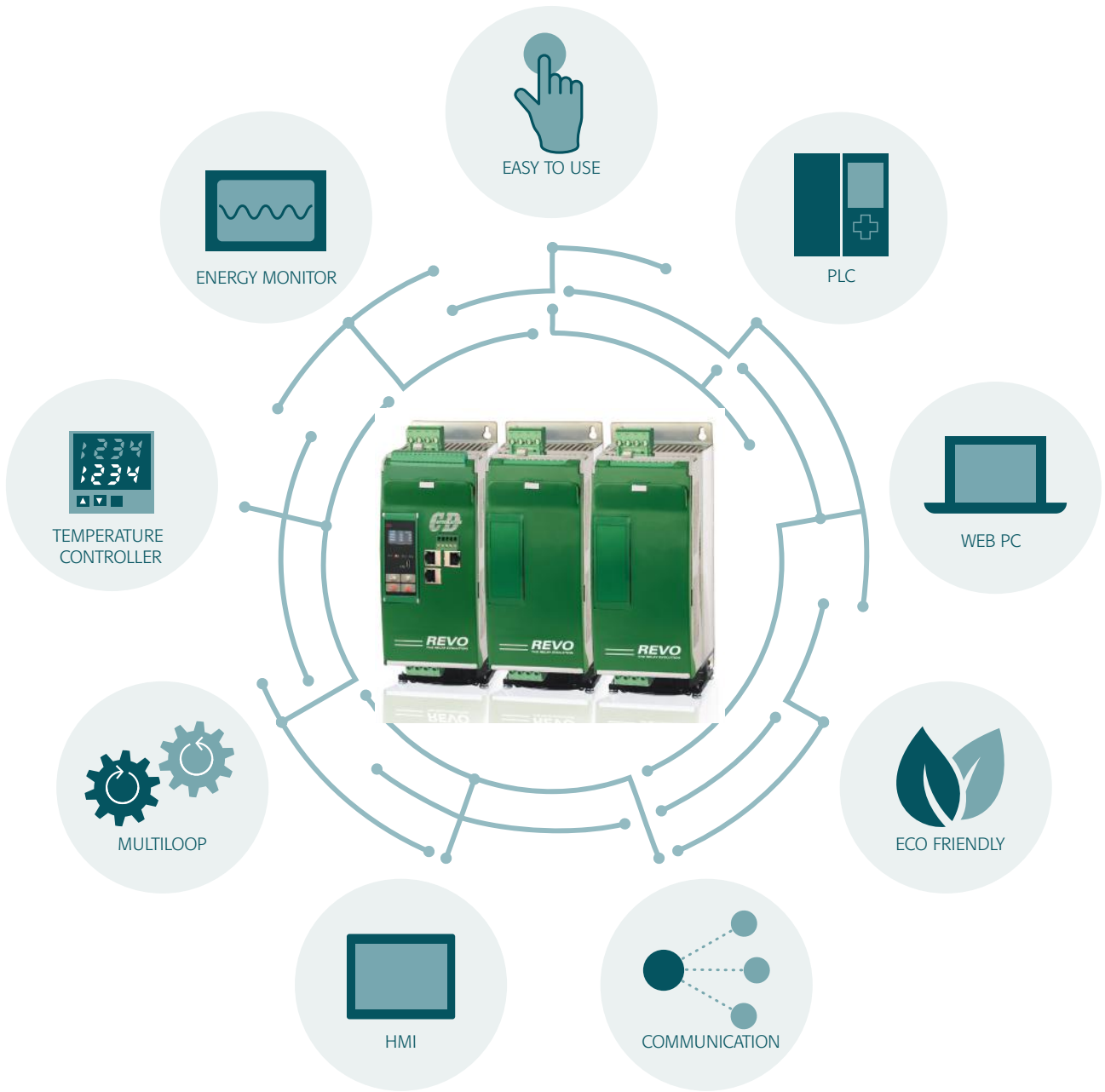

READ	WRITE
Set Point	Set Point
Alarm	One by one Configuration Parameters
Voltage	
Power	
Current	
Heater Break Alarm	
SCR Short Circuit Alarm	

EFFICIENT ENGINEERING

A key benefit is the incorporation of REVO PN into the **Siemens TIA Portal**. By using PROFINET I / O field bus or Modbus RTU and TCP communication with Siemens S1500 PLC, all REVO PN units will fall back on a shared database, a standardized operating concept and centralized services. You will get benefit from faster commissioning and reduced engineering overhead.

On our website www.cdautomation.com you can download libraries developed in the SIMATIC TIA Portal environment.

These libraries, integrated in the automation projects developed in the SIMATIC TIA Portal environment, will make the integration and dialogue of our products with the SIEMENS PLCs of the S7 1500 series simple and immediate for our customers.

The libraries will be compatible with REVO PC / PN products that will make use of Modbus TCP, Modbus RTU and PROFINET I / O communication.

CONFIGURATOR SOFTWARE

CDA Thyristor configurator software is free and available to download from our site www.cdautomation.com.

If the Order Code is in line with requirement, then REVO PN has been already configured in Factory and it's ready to use. You need the software only to modify the ordered configuration. Anyway we suggest to check the unit on the machine with the "Test unit" section.

To install the software, launch the program and follow the instructions on the screen. Run the software configurator and set the serial port of the PC with baudrate.

Test View

This page can be used to monitor and adjust the operation of the REVO PN while communicating with it in real time.

Main features available are:

- Set the total number of zones
- Select the source for Power Set Point
- Configure and Monitor the Digital Inputs
- Detect if an alarm is activated
- Set the power of each load
- Set minimum current threshold for each channel
- Main process variable display
- Source power set point display
- Total power limit setting
- Voltage and current calibration

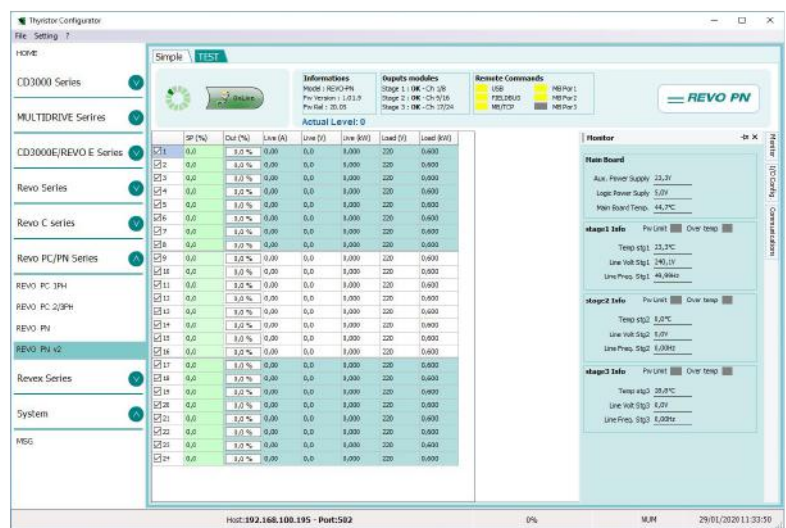

CONFIGURATION CABLE

To connect the Revo PN to computer is necessary use a standard micro USB cable (our code CCX).

The windows driver for USB connection is installed by thyristor configurator software installer.



FROM 4 UP TO 24 SINGLE PHASE INDEPENDENT CHANNELS SHARING THE SAME PHASE CONNECTION

Draw 104

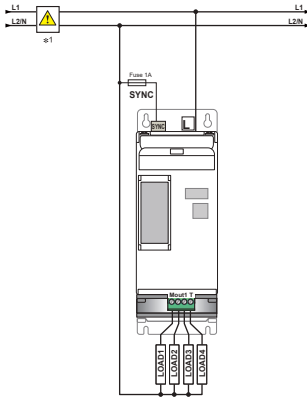

Draw 108

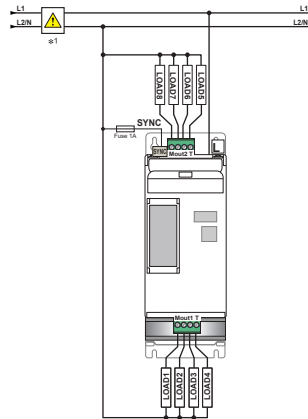

Draw 112

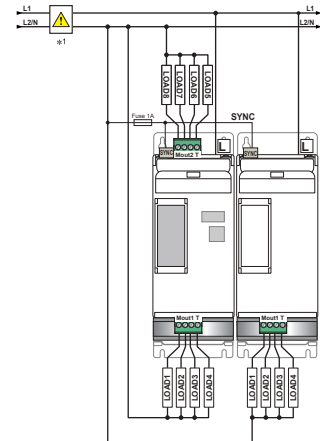

Draw 116

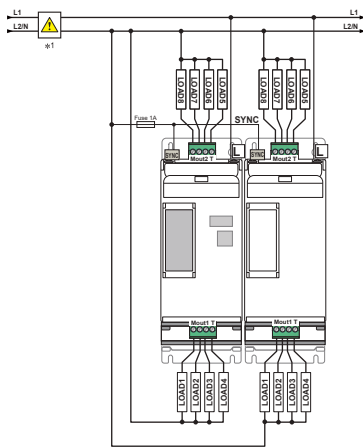

Draw 120

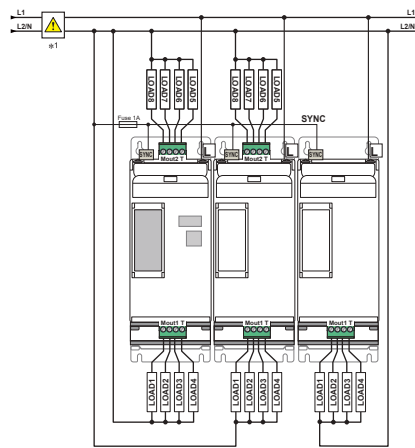

Draw 124

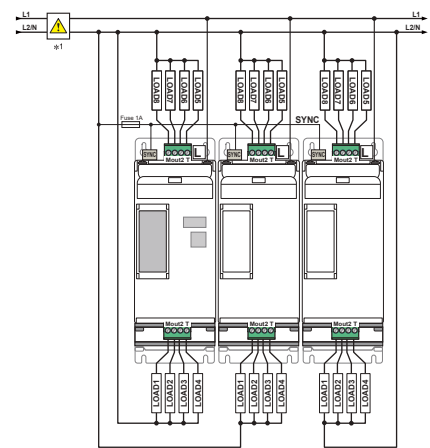

	1	2	3	4	5	6	7	8	9	10	11	12	13	14	15	16										
ORDER CODE	P	N	-	-	-	-	-	-	-	-	-	-	-	-	-	-										
CURRENT			3	4	5																					
description			code	code	code																					
1 PH 4 zones, all F1-N or F1-F2 (See draw 104)			1	0	4																					
1 PH 8 zones, all F1-N or F1-F2 (See draw 108)			1	0	8																					
1 PH 12 zones, all F1-N or F1-F2 (See draw 112)			1	1	2																					
1 PH 16 zones, all F1-N or F1-F2 (See draw 116)			1	1	6																					
1 PH 20 zones, all F1-N or F1-F2 (See draw 120)			1	2	0																					
1 PH 24 zones, all F1-N or F1-F2 (See draw 124)			1	2	4																					
MAX VOLTAGE					6																					
description					code																					
480V					4																					
COMMUNICATION							7																			
description							code																			
N°1 Ethernet Port, Modbus® TCP and n°3 Modbus® RTU							1																			
N°1 Profibus-DP® Port							4																			
N°1 Ethernet Port ProfiNet®							5																			
AUXILIARY VOLTAGE									8																	
description									code																	
24Vdc									4																	
INPUT											9															
description											code															
None, use only communication											0															
FIRING													10													
description													code													
Half cycle													1													
Single cycle													2													
CONTROL MODE															11											
description															code											
Open Loop															1											
Power Feed Back															2											
FUSES + FUSE HOLDER																	12									
description																	code	note								
Low Speed Fuse & Fuse Holder for each channel (see Option Tab on page 11)																	...	1								
Extra Rapid Fuse & Fuse Holder for each channel																	F									
FAN VOLTAGE																			13							
description																			code	note						
24Vdc fan																			3							
APPROVALS																					14					
description																					code	note				
CE EMC																					0					
MANUAL																							15			
description																							code	note		
None																							0			
Italian																							1			
English																							2			
German																							3			
French																							4			
VERSION																									16	
description																									code	note
Each channel has a dedicated current sensor integrated in the units																									4	

Note (1): These fuses do not protect the Thyristors. You need external fuses. This solution is recommended for current IRSW Lamp.

FROM 12 UP TO 24 SINGLE PHASE INDEPENDENT CHANNELS BALANCED ON THE THREE DIFFERENT PHASES

Draw 412

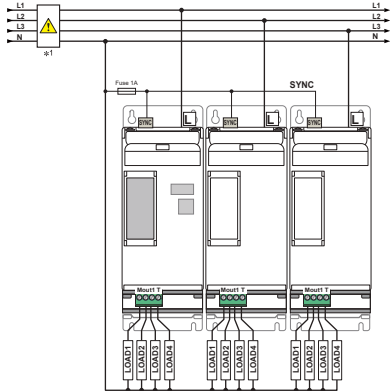

Draw 612

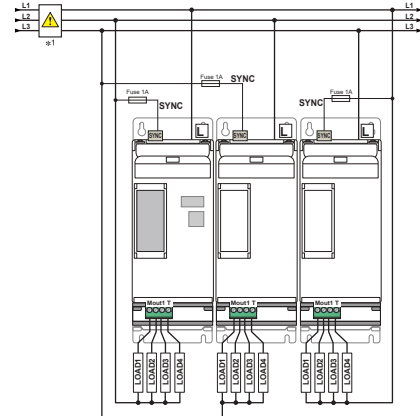

Draw 424

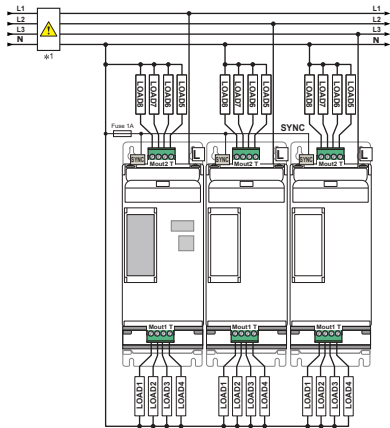

Draw 624

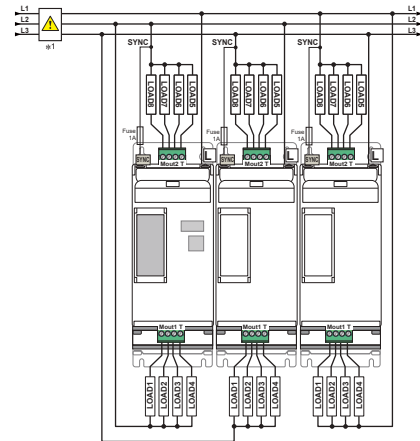

	1	2	3	4	5	6	7	8	9	10	11	12	13	14	15	16										
ORDER CODE	P	N	-	-	-	-	-	-	-	-	-	-	-	-	-	-										
CURRENT			3	4	5																					
description				code	note																					
1PH 12 zones (n°4 zones F1-N; n°4 zones F2-N; n°4 zones F3-N) (draw 412)			4	1	2																					
1PH 24 zones (n°8 zones F1-N; n°8 zones F2-N; n°8 zones F3-N) (draw 424)			4	2	4																					
1PH 12 zones (n°4 zones F1-F2; n°4 zones F2-F3; n°4 zones F1-F3) (draw 612)			6	1	2																					
1PH 24 zones (n°8 zones F1-F2; n°8 zones F2-F3; n°8 zones F1-F3) (draw 624)			6	2	4																					
MAX VOLTAGE					6																					
description					code	note																				
480V					4																					
COMMUNICATION							7																			
description							code	note																		
N°1 Ethernet Port, Modbus® TCP and n°3 Modbus® RTU							1																			
N°1 Profibus-DP® Port							4																			
N°1 Ethernet Port ProfiNet®							5																			
AUXILIARY VOLTAGE									8																	
description									code	note																
24Vdc									4																	
INPUT											9															
description											code	note														
None, use only communication											0															
FIRING													10													
description													code	note												
Half cycle													1													
Single cycle													2													
CONTROL MODE															11											
description															code	note										
Open Loop															1											
Power Feed Back															2											
FUSES + FUSE HOLDER																	12									
description																	code	note								
Low Speed Fuse & Fuse Holder for each channel (see Option Tab on page 11)																	...	1								
Extra Rapid Fuse & Fuse Holder for each channel																	F									
FAN VOLTAGE																			13							
description																			code	note						
24Vdc fan																			3							
APPROVALS																					14					
description																					code	note				
CE EMC																					0					
MANUAL																							15			
description																							code	note		
None																							0			
Italian																							1			
English																							2			
German																							3			
French																							4			
VERSION																									16	
description																									code	note
Each channel has a dedicated current sensor integrated in the units																									4	

Note (1): These fuses do not protect the Thyristors. You need external fuses. This solution is recommended for current IRSW Lamp.

MODBUS® is a registered trademark of Schneider Automation, Inc. PROFIBUS-DP® is a registered trademark of PROFIBUS Nutzerorganisation e.V. PROFINET® is a registered trademark of PROFINET International (PI). All trademarks are the property of their respective owners.

DRAMATIC REDUCTION IN CABLE WIRING

Compare the new **REVO PN** to a **traditional system** and you save time, wiring and space:

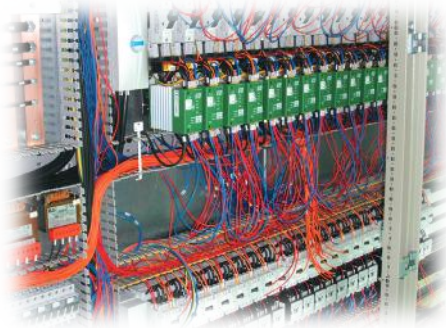

How many Zones/loops do you sell in one year?

Make a calculation of what you can save and you only have one decision to take.

How much it costs you each wire?

With REVO PN you save 6 wires for each zone and the related wiring accessories, significantly reducing the space used. Try to calculate the actual savings.

Our staff is at your disposal for further information

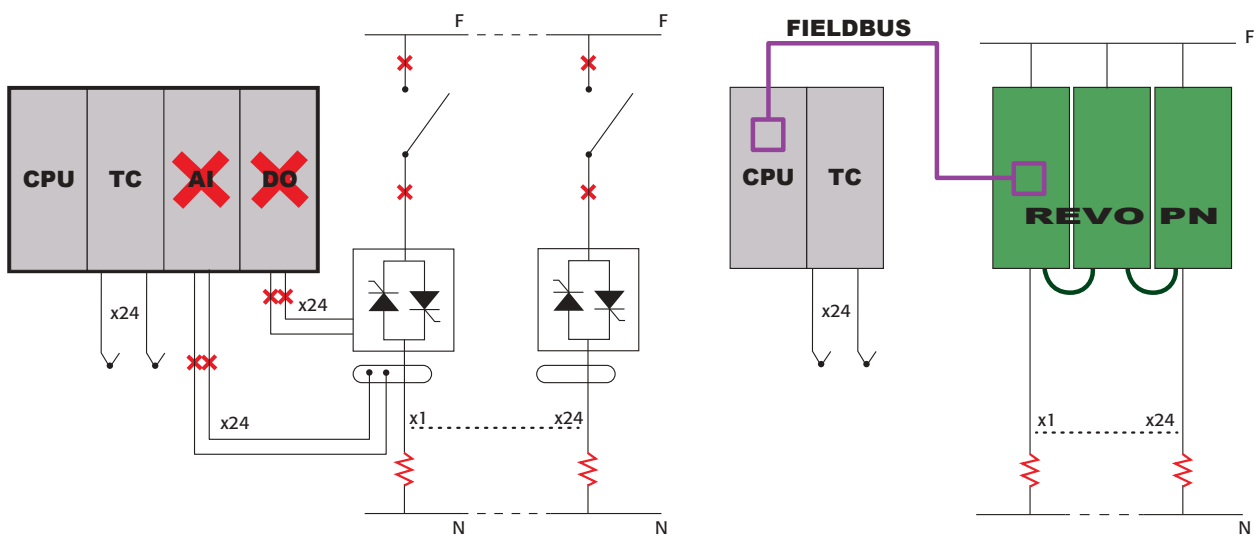

TRADITIONAL SYSTEM

REVO PN SYSTEM

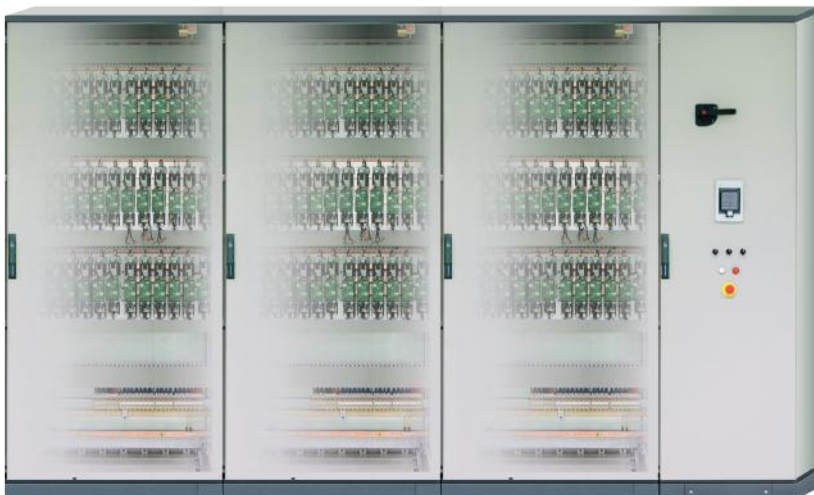

REVO PN's compact design results in multiple units in small footprint size

- In the control panel shown on the right, a 800x2000 mm layout contains 168 zones of 25A.
- The units can be connected via communication to a PLC or to a multi loop temperature controller.
- The connection to ProfiNet® can be done via switches or chains by using the two RJ 45 ports.
- The main components of the power part are already included within each module (Fuse, Thyristor and Current Transformer).
- You will only have to wrap the input wires for input and output for each heating element.
- Communication will provide the main diagnostics on load, SCR and fuses.
- Internal bus connection - RS485 proprietary communication protocol

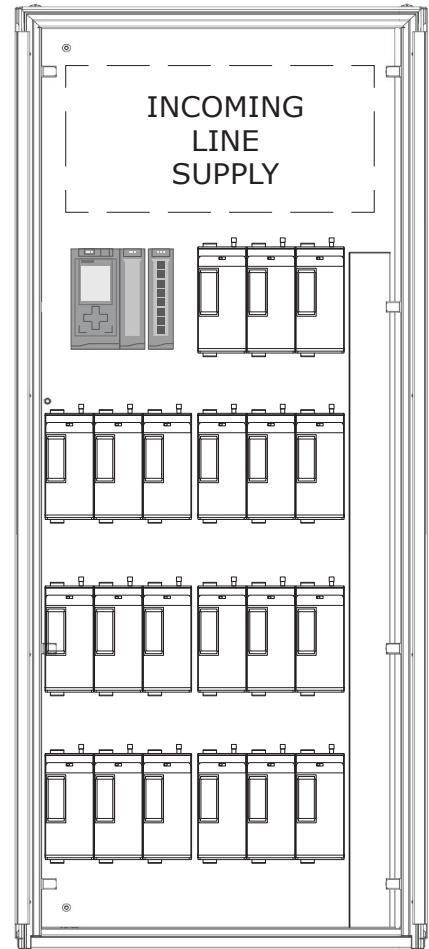

Column layout with 56 three-phase zones

Easy access for maintenance and easy fuse replacement

REVO PN have internal fuse extrarapid at low I²T for the thyristor protection of against the short-circuits. The Fuses must have I²T 20% less than thyristor's I²T.



Option Table

Fuse Type	Max Current	CODE
Extra Rapid Fuse (Standard)	32A	F
Low Speed fuse	2A	A
Low Speed fuse	4A	B
Low Speed fuse	6A	C
Low Speed fuse	8A	D
Low Speed fuse	10A	E
Low Speed fuse	12A	G
Low Speed fuse	16A	H
Low Speed fuse	20A	I
Low Speed fuse	25A	L
Low Speed fuse	32A	N
Low Speed fuse	Various	V

All low speed fuses do not protect thyristor module

REVO PB

REVO PN FAMILY

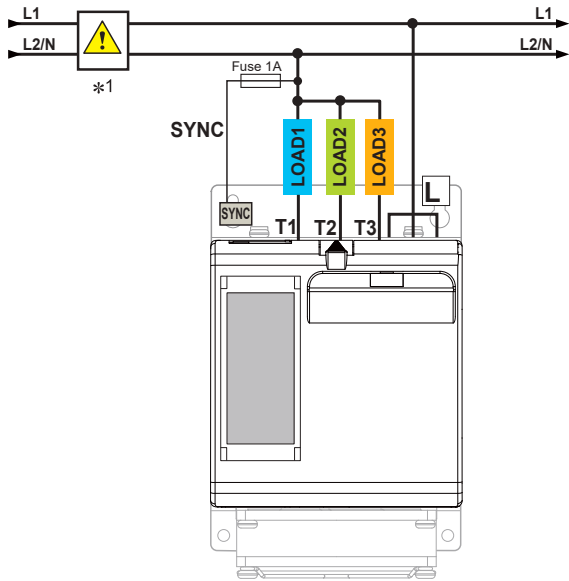

N°3 single phase independent channels sharing the same phase connection

How to tune N°3 off REVO PB to have 9 channels balanced on the three different phases

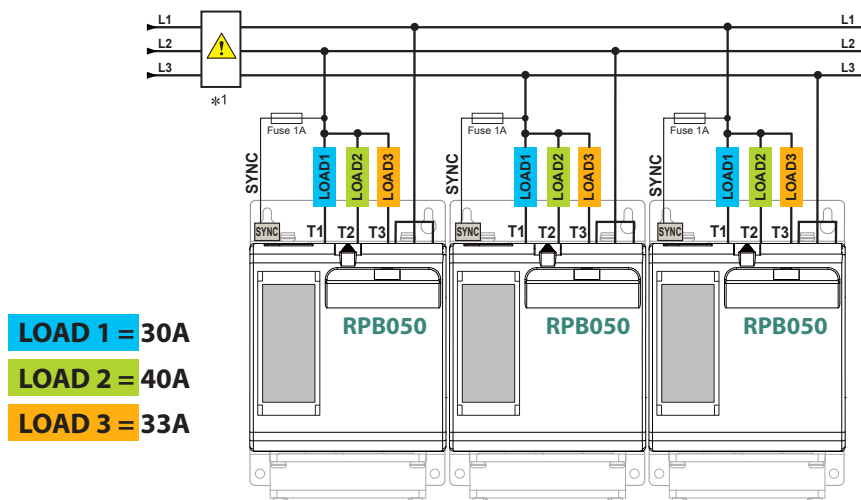
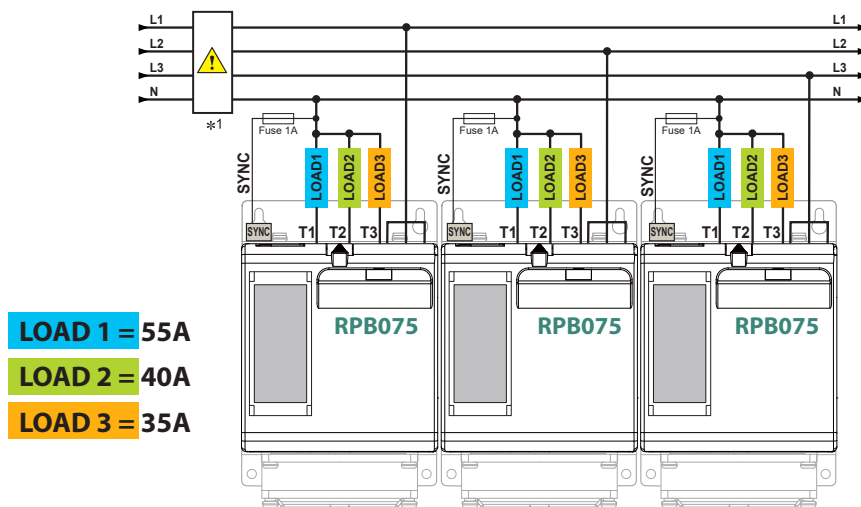

REVO PB ORDER CODE

Three zones thyristor controller with power optimization algorithm

Created specifically for industrial multi-zone applications, REVO PB can be configured to control between 3 and 9 channels/zones.

Each zone is sized for 35A / 50A / 75A / 90A max.

- Three zones thyristor controller with power optimization algorithm
- Fixed extrarapid fuses
- Current transformers
- Firing mode: Single cycle, Half cycle
- Load and SCR diagnostics
- Outputs for alarms
- Size: SR25.
Dimensions: H165xW116xD183; 2,35 Kg



	1	2	3	4	5	6	7	8	9	10	11	12	13	14	15	16
ORDER CODE	P	B	3	-	-	-	-	-	-	-	-	-	-	-	-	-

CURRENT	4	5	6	
description		code	note	
35A	0	3	5	
50A	0	5	0	
75A	0	7	5	
90A	0	9	0	

MAX VOLTAGE	7	
description	code	note
480V	4	
600V	6	

AUXILIARY VOLTAGE	8	
description	code	note
24Vdc	4	

INPUT	9	
description	code	note
RS485 Modbus RTU Communication and DI	0	

FIRING	10	
description	code	note
Half cycle	0	
Single cycle	1	

CONTROL MODE	11	
description	code	note
No Feed-back	1	
Power Vxl	2	

OPTION	12	
description	code	note
Display, Heater Break alarm	0	

FAN VOLTAGE	13	
description	code	note
24Vdc fan	3	

APPROVALS	14	
description	code	note
CE EMC for European market	0	

LOAD TYPE	15	
description	code	note
1PH Normal resistance	0	
1PH IRSW Infrared Short Wave	1	

VERSION	16	
description	code	note
Standard version	0	

REVO HMI

Several REVO PB or REVO PN can be connected to a REVO HMI series panel, equipped with a color display and software for the management up to 24 regulation zones.

The system is flexible and scalable, with few steps you can add groups of zones of 4 or 8 loops per page, view trends and rename zones.



FIELD BUS MODULE



Technical Specification

- Up to n°24channel with n° 8 **REVO PB** can be connected for each terminal module
- Secondary communication port to connect REVO HMI
- Main process variable available
- 24Vdc Power Supply
- Simplified configuration

ORDER CODE	1	2		3	4	5	6	7		8	9	10	11	12	13	14	15	16
	T	U	-	R	S	4	8	5	-	-	-	-	-	R	P	B	-	-

FIELD BUS OR COMMUNICATION	8	9	10	
description	code			note
N° 1 Modbus TCP + N° 1 Modbus RTU slave	T	C	P	
N° 1 ProfiNet IO + N° 1 Modbus RTU slave	P	N	T	
N° 1 ProfiBus DP + N° 1 Modbus RTU slave	P	D	P	
N° 1 Ethernet IP + N° 1 Modbus RTU slave	E	I	P	

SECONDARY COMMUNICATION PORT	11	
description	code	note
None	0	
Modbus TCP Slave	1	1

CONFIGURATION	12	13	14	
description	code			note
REVO PB	R	P	B	

N° ZONES	15	16	
description	code		note
Not configured	0	0	
3	0	3	
6	0	6	
9	0	9	
12	1	2	
15	1	5	
18	1	8	
21	2	1	
24	2	4	

Note (1): Not available with Modbus TCP Field Bus Communication (T-C-P on digit 8-9-10)

INFRARED OVEN AND THERMOFORMING

Infrared lamps with medium and short waveform

REVO PN is the best solution to control all types of infrared lamps.

The robust junction with high I²T allows it to drive short-wave IR lamps.

There are several types of soft start, which cancels the phenomenon of flickering.

The synchronization makes the power factor close to 1.

Power Network voltage fluctuations are compensated instantly via the feedback in the unit.



PLASTIC EXTRUSION MACHINE

Automation solution for extrusion lines

- Scalable power management, single extruder or full line.
- Modules of 12 or 24 zones already divided into three phases or one phase from 4 to 24 zones.
- Cyclic reading and writing of process variables.
- Short circuit SCR and load brake diagnostics.
- Reduced power consumption due to power grid fluctuations through live control.
- Maintains instantaneous power in the contractual limits with a power factor close to one.
- Strong bulk reduction and cabling for co-extrusion systems that can pass 100 zones.

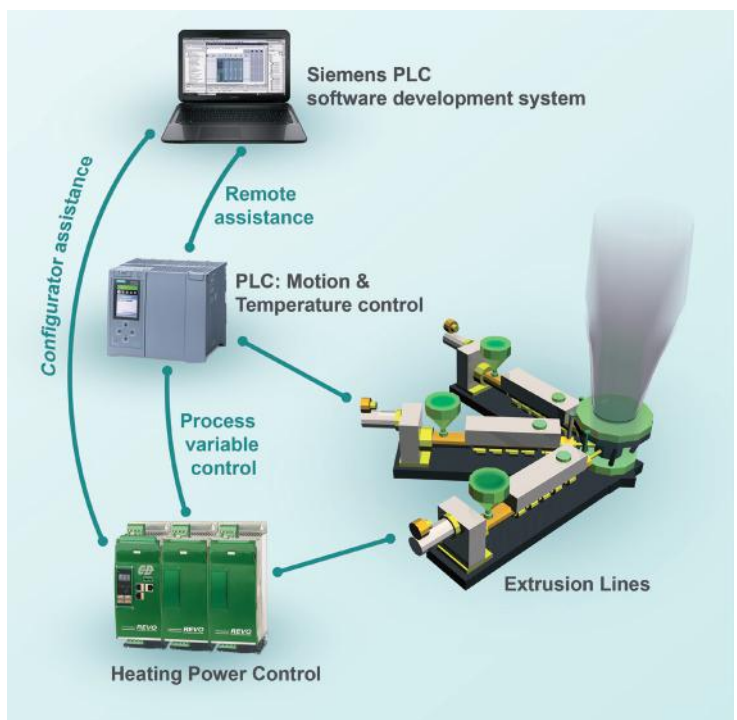



Italy

CD Automation Srl
Via Picasso, 34/36
20025 Legnano MI
Italy
T +39 0331 577479
F +39 0331 579479
sales@cdautomation.com
www.cdautomation.com

United Kingdom

CD Automation UK Ltd
Unit 9 Harvington Business Park
Brampton Road, Eastbourne
East Sussex, BN22 9BN
England
T +44 1323 811100
info@cdautomation.co.uk
www.cdautomation.co.uk

India

M/s Toshcon CD Automation Pvt. Ltd.
H1 - 75 Gegal Industrial Area
Ajmer - 305023 (Raj.)
India
T +91 145 2791112
T +91 145 6450601/2/3
sales.cd@toshcon.com
www.cdautomation.in